

## Metallized Polyester Film Capacitors MKT Radial Epoxy Lacquered Type

**APPLICATIONS**

Blocking and coupling. Bypass and energy reservoir

**MARKING**

C-value; tolerance; rated voltage; manufacturer's symbol; code for dielectric material and construction

**DIELECTRIC**

Polyester film

**ELECTRODES**

Vacuum deposited aluminium

**COATING**

Flame retardant epoxy material (UL-class 94 V-0)

**CONSTRUCTION**

Wound mono construction

**LEADS**

Tinned wire

**CAPACITANCE RANGE (E12 SERIES)**

0.001 to 1.0  $\mu$ F

**CAPACITANCE TOLERANCE**

$\pm 10\%$ ;  $\pm 5\%$

**RATED (DC) VOLTAGE**

100 V; 250 V; 400 V; 630 V

**RATED (AC) VOLTAGE**

63 V; 160 V; 220 V; 250 V

**CLIMATIC CATEGORY**

55/105/56

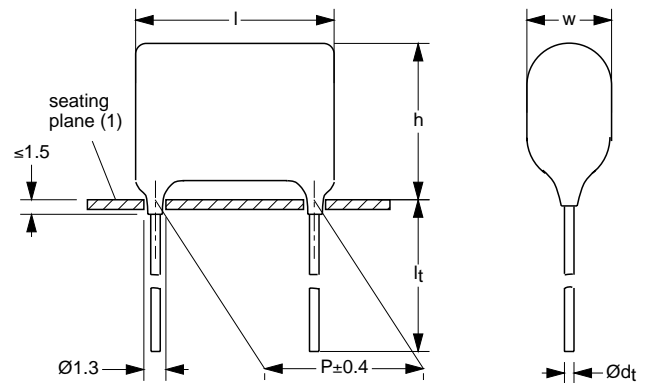

Dimensions in mm.

(1) Hole  $\varnothing 1.0$  for  $d_t = 0.6$  mm.

**RATED TEMPERATURE**

85 °C

**MAXIMUM APPLICATION TEMPERATURE**

105 °C

**REFERENCE SPECIFICATIONS**

IEC 60384-2

**PERFORMANCE GRADE**

Grade 1 (long life)

**MATERIALS**

Qualified in accordance with UL94 V-0

**FEATURES**

Available taped and loose in box

**DETAIL SPECIFICATION**

For more detailed data and test requirements see "Type detail specification HQN-384-02/102"





$U_{Rdc} = 100\text{ V}; U_{Rac} = 63\text{ V}$

C ( $\mu\text{F}$ )	DIMENSIONS $w_{\text{max}} \times h_{\text{max}} \times l_{\text{max}}$ (mm)	MASS (g)	CATALOG NUMBER 2222 469 ..... AND PACKAGING			
			LOOSE IN BOX			REEL
			$l_t = 4.0 +1.0/-0.5\text{ mm}$		$l_t = 22.0 \pm 4.0\text{ mm}$	
			C-tol = $\pm 10\%$	SPQ	SPQ	SPQ
last 5 digits of catalog number						
<b>Pitch = 10.0 <math>\pm</math>0.4 mm; <math>d_t = 0.60 \pm 0.06\text{ mm}</math></b>						
0.056	4.0 $\times$ 9.3 $\times$ 12.5	0.4	25563	2000	1500	1500
0.068			25683			
0.082			25823			
0.1			25104			
0.12	4.3 $\times$ 9.7 $\times$ 12.5	0.5	25124	2000	1500	1500
0.15	3.9 $\times$ 9.2 $\times$ 12.5	0.4	25154	2000	1500	1500
0.18	4.2 $\times$ 9.5 $\times$ 12.5	0.4	25184	2000	1500	1500
0.22	4.5 $\times$ 9.9 $\times$ 12.5	0.5	25224	2000	1500	1300
0.27	4.2 $\times$ 9.5 $\times$ 12.5	0.4	25274	2000	1500	1500
0.33	4.6 $\times$ 9.9 $\times$ 12.5	0.5	25334	2000	1500	1300
0.39	4.0 $\times$ 9.3 $\times$ 12.5	0.4	25394	2000	1500	1500
0.47	4.2 $\times$ 9.5 $\times$ 12.5	0.4	25474	2000	1500	1500
0.56	4.6 $\times$ 9.9 $\times$ 12.5	0.5	25564	2000	1500	1300
0.68	5.0 $\times$ 10.3 $\times$ 12.5	0.5	25684	1500	1250	1200
0.82	5.5 $\times$ 10.8 $\times$ 12.5	0.6	25824	1500	1000	1100
1.0	6.0 $\times$ 11.3 $\times$ 12.5	0.6	25105	1250	1000	1000

$U_{Rdc} = 250\text{ V}; U_{Rac} = 160\text{ V}$

C ( $\mu\text{F}$ )	DIMENSIONS $w_{\text{max}} \times h_{\text{max}} \times l_{\text{max}}$ (mm)	MASS (g)	CATALOG NUMBER 2222 469 ..... AND PACKAGING			
			LOOSE IN BOX			REEL
			$l_t = 4.0 +1.0/-0.5\text{ mm}$		$l_t = 22.0 \pm 4.0\text{ mm}$	
			C-tol = $\pm 10\%$	SPQ	SPQ	SPQ
last 5 digits of catalog number						
<b>Pitch = 10.0 <math>\pm</math>0.4 mm; <math>d_t = 0.60 \pm 0.06\text{ mm}</math></b>						
0.027	4.2 $\times$ 9.5 $\times$ 12.5	0.4	45273	2000	1500	1500
0.033	4.6 $\times$ 9.9 $\times$ 12.5	0.5	45333	2000	1500	1300
0.039	4.0 $\times$ 9.3 $\times$ 12.5	0.4	45393	2000	1500	1500
0.047	4.1 $\times$ 9.4 $\times$ 12.5	0.4	45473	2000	1500	1500
0.056	4.0 $\times$ 9.3 $\times$ 12.5	0.4	45563	2000	1500	1500
0.068	4.1 $\times$ 9.4 $\times$ 12.5	0.4	45683	2000	1500	1500
0.082	4.4 $\times$ 9.7 $\times$ 12.5	0.5	45823	2000	1500	1500
0.1	4.0 $\times$ 9.3 $\times$ 12.5	0.4	45104	2000	1500	1500
0.12	4.3 $\times$ 9.7 $\times$ 12.5	0.5	45124	2000	1500	1500
0.15	4.8 $\times$ 10.1 $\times$ 12.5	0.5	45154	2000	1250	1300
0.18	5.2 $\times$ 10.5 $\times$ 12.5	0.5	45184	1500	1000	1200
0.22	5.8 $\times$ 11.1 $\times$ 12.5	0.6	45224	1500	1000	1100

# MKT 469

Vishay BCcomponents

Metallized Polyester Film Capacitors  
MKT Radial Epoxy Lacquered Type



$U_{Rdc} = 400\text{ V}$ ;  $U_{Rac} = 220\text{ V}$

C ( $\mu\text{F}$ )	DIMENSIONS $w_{\text{max}} \times h_{\text{max}} \times l_{\text{max}}$ (mm)	MASS (g)	CATALOG NUMBER 2222 469 ..... AND PACKAGING			
			LOOSE IN BOX			REEL
			$l_t = 4.0 +1.0/-0.5\text{ mm}$		$l_t = 22.0 \pm 4.0\text{ mm}$	
			C-tol = $\pm 10\%$	SPQ	SPQ	SPQ
last 5 digits of catalog number						
Pitch = $10.0 \pm 0.4\text{ mm}$ ; $d_t = 0.60 \pm 0.06\text{ mm}$						
0.001	4.5 × 9.9 × 12.5	0.5	55102	2000	1500	1300
0.0012			55122			
0.0015			55152			
0.0018			55182			
0.0022	4.0 × 9.3 × 12.5	0.4	55222	2000	1500	1500
0.0027	4.3 × 9.7 × 12.5	0.5	55272	2000	1500	1500
0.0033	4.6 × 9.9 × 12.5	0.5	55332	2000	1500	1300
0.0039	4.0 × 9.3 × 12.5	0.4	55392	2000	1500	1500
0.0047	4.1 × 9.5 × 12.5	0.4	55472	2000	1500	1500
0.0056	4.6 × 9.9 × 12.5	0.5	55562	2000	1500	1300
0.0068	4.2 × 9.5 × 12.5	0.4	55682	2000	1500	1500
0.0082	4.6 × 9.9 × 12.5	0.5	55822	2000	1500	1300
0.01	4.1 × 9.4 × 12.5	0.4	55103	2000	1500	1500
0.012	4.5 × 9.9 × 12.5	0.5	55123	2000	1500	1300
0.015	4.1 × 9.4 × 12.5	0.4	55153	2000	1500	1500
0.018	4.5 × 9.9 × 12.5	0.5	55183	2000	1500	1300
0.022	4.0 × 9.3 × 12.5	0.4	55223	2000	1500	1500
0.027	4.2 × 9.5 × 12.5	0.4	55273	2000	1500	1500
0.033	4.6 × 9.9 × 12.5	0.5	55333	2000	1500	1300
0.039	5.0 × 10.3 × 12.5	0.5	55393	1500	1250	1200
0.047	4.1 × 9.4 × 12.5	0.4	55473	2000	1500	1500
0.056	4.4 × 9.7 × 12.5	0.5	55563	2000	1500	1500
0.068	4.8 × 10.1 × 12.5	0.5	55683	2000	1250	1300
0.082	5.4 × 10.8 × 12.5	0.6	55823	1500	1000	1200
0.1	5.7 × 11.0 × 12.5	0.6	55104	1500	1000	1100

$U_{Rdc} = 630\text{ V}$ ;  $U_{Rac} = 250\text{ V}$

C ( $\mu\text{F}$ )	DIMENSIONS $w_{\text{max}} \times h_{\text{max}} \times l_{\text{max}}$ (mm)	MASS (g)	CATALOG NUMBER 2222 469 ..... AND PACKAGING			
			LOOSE IN BOX			REEL
			$l_t = 4.0 +1.0/-0.5\text{ mm}$		$l_t = 22.0 \pm 4.0\text{ mm}$	
			C-tol = $\pm 10\%$	SPQ	SPQ	SPQ
last 5 digits of catalog number						
Pitch = $10.0 \pm 0.4\text{ mm}$ ; $d_t = 0.60 \pm 0.06\text{ mm}$						
0.01	4.1 × 9.4 × 12.5	0.4	65103	2000	1500	1500
0.012	4.5 × 9.9 × 12.5	0.5	65123	2000	1500	1300
0.015	4.9 × 10.2 × 12.5	0.5	65153	2000	1250	1200
0.018	5.4 × 10.8 × 12.5	0.6	65183	1500	1000	1100
0.022	4.8 × 10.1 × 12.5	0.5	65223	2000	1250	1300
0.027	5.3 × 10.7 × 12.5	0.6	65273	2000	1000	1200
0.033	5.9 × 11.2 × 12.5	0.6	65333	1500	1000	1100



MAXIMUM RMS VOLTAGE (SENAWE) AS A FUNCTION OF FREQUENCY

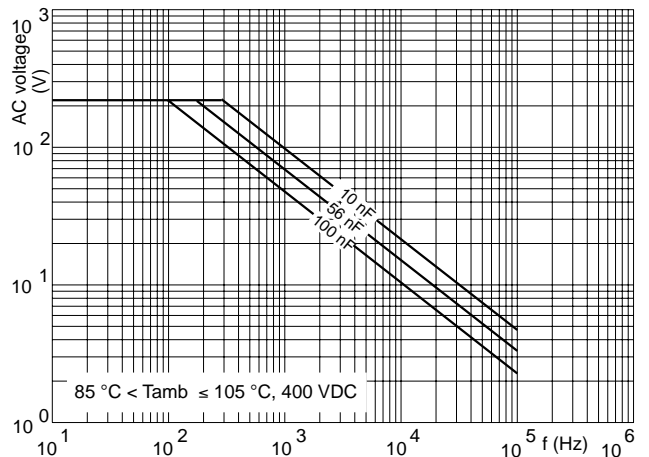
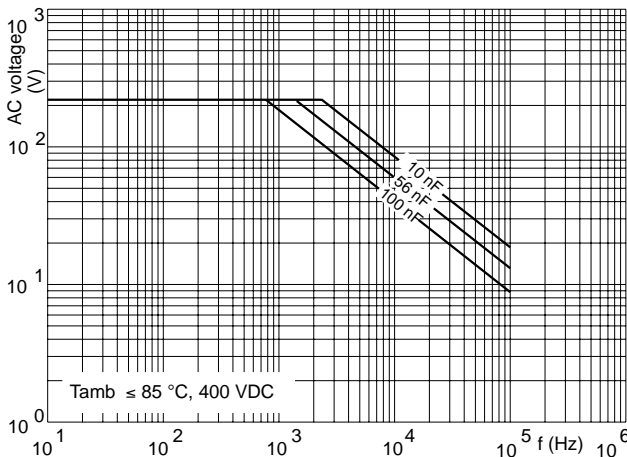
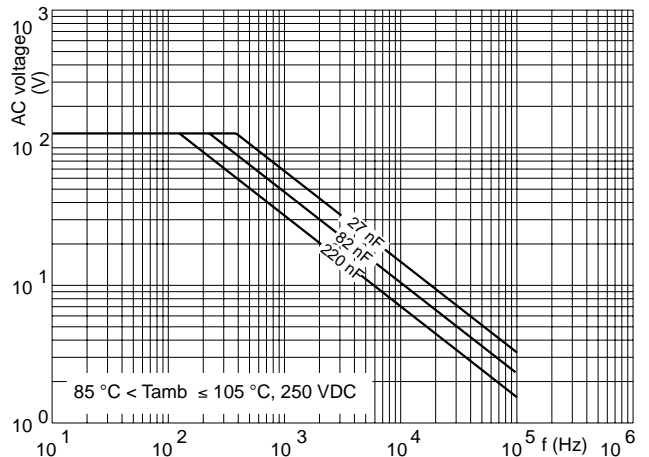
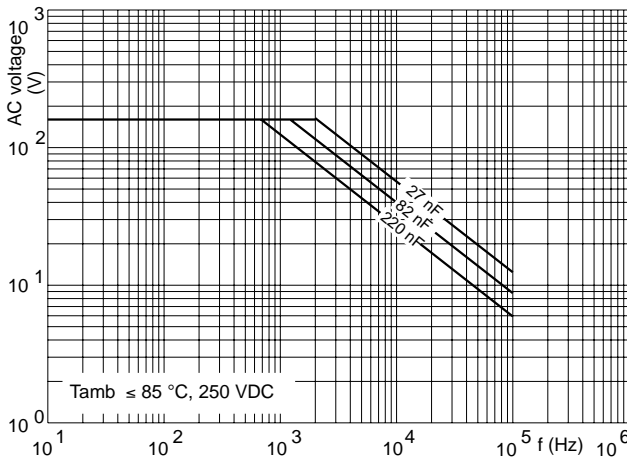
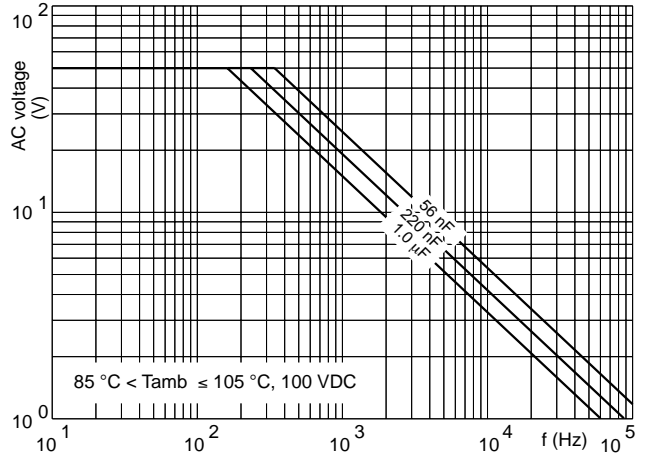
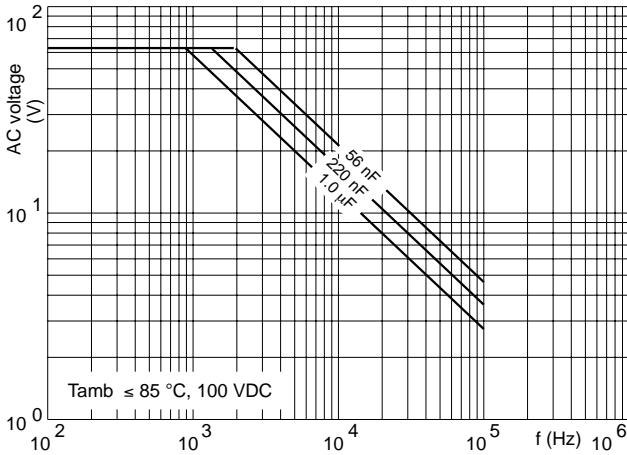

# MKT 469

Vishay BCcomponents

Metallized Polyester Film Capacitors  
MKT Radial Epoxy Lacquered Type

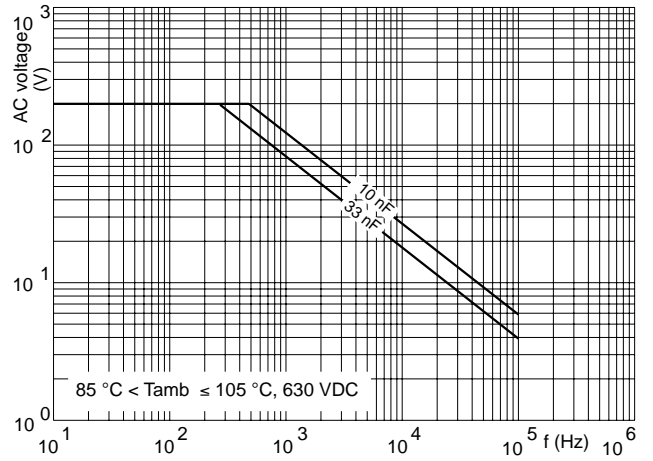
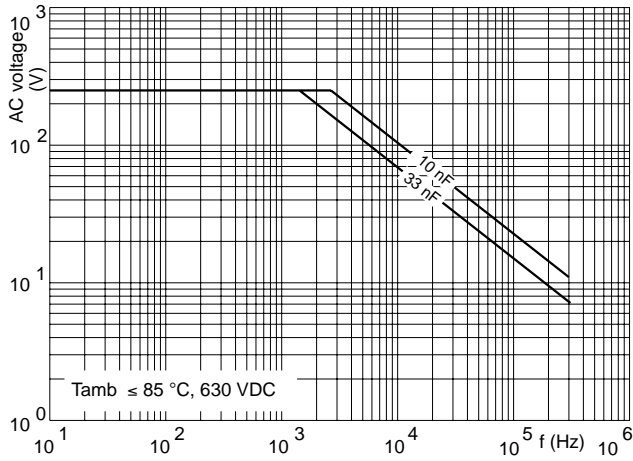

## CAPACITANCE

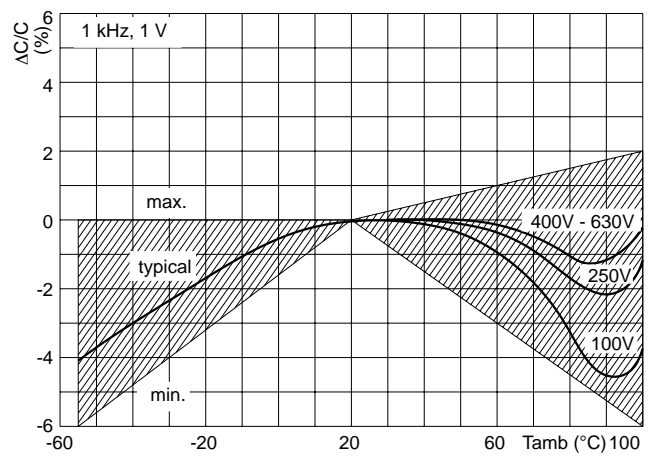
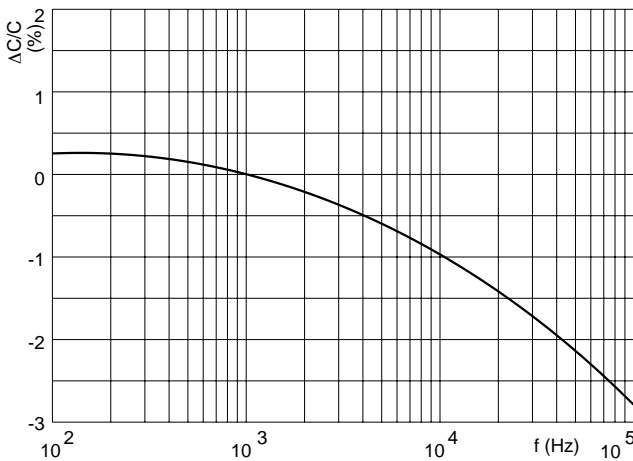

## IMPEDANCE

